

# VOLKSWAGEN

AKTIENGESELLSCHAFT

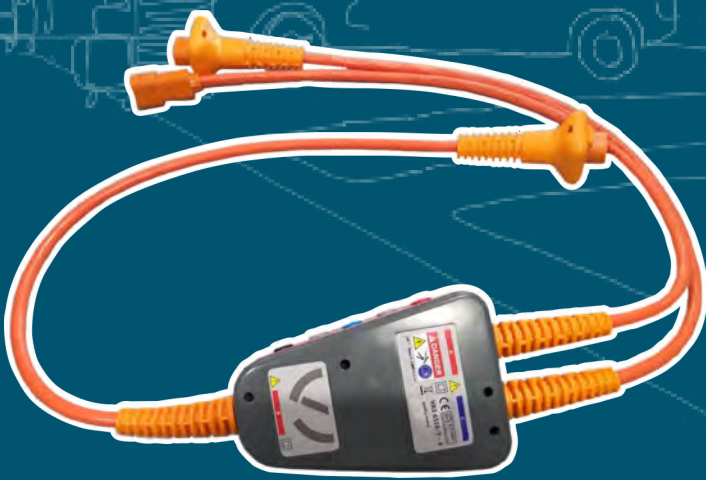

## Operating manual

High-voltage test adapter VAS 6558/9-4



Revision	Date	Reason
V00	23.10.2020	First edition
V01	15.12.2020	Addition of cMETus registration number

## Legal notice

### Manufacturer

CAR-connect GmbH  
Am Egelingsberg 8  
38542 Leiferde, Germany  
Phone: +49 (0) 5373 92197-0  
Fax: +49 (0) 5373 92197-88  
  
[info@car-connect.cc](mailto:info@car-connect.cc)  
[www.car-connect.cc](http://www.car-connect.cc)

### Reproduction

Reproduction or reprinting, whether in whole or in part, always requires the written permission of the manufacturer.

### Copyright

TRANSLATION OF THE ORIGINAL OPERATING MANUAL

All rights reserved.

All text, images and graphics are subject to copyright and other intellectual property laws.

Copyright 2020 CAR-connect GmbH.

### Image sources

Symbols for warnings, prohibitions, mandatory actions and standards are taken from publicly accessible sources, such as the Internet. CAD product images and product photos are provided by the manufacturer. Images showing the product in use are provided with a reference to the source.

# Contents

<b>LEGAL NOTICE</b>	<b>2</b>
<b>CONTENTS</b>	<b>3</b>
<b>INTRODUCTION</b>	<b>4</b>
Preliminary information	4
Validity of the declaration of conformity	4
Manufacturer specifications	4
<b>SAFETY</b>	<b>5</b>
Warning levels	5
Important safety instructions	6
Intended use	7
Requirements for the target group	7
Duties of the operator	7
<b>PRODUCT DESCRIPTION</b>	<b>8</b>
Scope of delivery	8
Design	8
Symbols and connections	9
Wiring diagram	10
Technical data	11
<b>OPERATION</b>	<b>12</b>
Startup	13
Measurement on the air conditioning compressor	13
Measurement on the high-voltage cable	14
Detaching the plug connections	15
Cleaning	16
Storage and transportation	16
Disposal	16
Maintenance	16
<b>HELP</b>	<b>17</b>
Warranty	17
Customer service	17

## Preliminary information

Read through this operating manual carefully before using the product.

The product is delivered with a USB stick containing the operating manual in various languages. You can find the current version and additional languages on our homepage.

The operating manual is an essential part of the product and must be kept together with the product. If you sell or transfer ownership of the product, the operating manual must be handed over to the new operator.

In addition to this operating manual, you must observe all relevant regulations for diagnostics or troubleshooting of intrinsically safe high-voltage systems in road vehicles. This includes but is not limited to: instructions for the vehicle manufacturer's diagnostics systems, company-specific safety requirements and the state of the art for working with high-voltage systems.

## Validity of the declaration of conformity

The declaration of conformity applies to the product described in the operating manual. Any changes, modifications or extensions shall void the declaration of conformity and the risk assessment.

## Manufacturer specifications

### CAR-connect GmbH



Since its founding, our company has focused on groundbreaking solutions for electromobility. CAR-connect develops and produces custom solutions for the automotive industry, repair shops and special vehicle fleets.

Our core business is developing and producing innovative high-voltage charging technology for electric vehicles. Our portfolio also includes measurement and diagnostic technology for the entire vehicle and battery analysis equipment.

With extensive experience in software and hardware development, CAR-connect is your dependable partner at every production stage, from prototyping to series production.

CAR-connect GmbH – Experience, Expertise and Innovation – MADE IN GERMANY

This safety chapter provides information about the following:

- The warning levels contained in this operating manual
- Important safety instructions for the product
- Intended use of the product
- Requirements for the target group

This operating manual is only valid for the following product:

Item number      22101026

Designation      High-voltage test adapter VAS 6558/9-4

## Warning levels

This chapter provides information about the warning levels used in this operating manual.

### **DANGER**

Failure to observe the safety instructions **WILL** result in death or serious injury!

### **WARNING**

Failure to observe with the safety instructions **CAN** result in death or serious injury!

### **CAUTION**

Failure to observe the safety instructions **CAN** result in minor physical injury!

# Important safety instructions

This chapter contains the safety instructions that must be observed when handling the product.



## DANGER

### Danger of fatal electric shock!

The electrical voltage in other systems is lethal and will cause death by electric shock!

- Do not use the product for measurements on utility power circuits!
- Never attempt to power other devices with the product!



## WARNING

### Danger of fatal electric shock!

The electrical voltage in high-voltage systems is lethal and can cause death by electric shock!

Liquids, condensation and high humidity can cause short circuits!

- Do not let the product come into contact with liquids!
- Use the product only in dry and enclosed spaces!



## WARNING

### Danger of fatal electric shock!

The electrical voltage in the product is dangerous and can cause serious injury or death from electric shock!

Defective and damaged products cannot guarantee protection against electrical voltage!

- Do not let the product come into contact with chemicals!
- Replace a defective or damaged product immediately!
- Never attempt to repair or tamper with the product!

## Intended use

Use the product only in accordance with this operating manual; otherwise the electrical hazard protection provided by the product can no longer be guaranteed.

The product is used to adapt the VAS 6558/VAS 6558A high-voltage measurement module to the vehicle-side plug connection specified by the vehicle manufacturer in the guided fault finding.

The product may only be used on high-voltage systems that have been certifiably de-energized.

The product must not be used to test that the circuit is de-energized.

The product is suitable for the following measurements:

- Insulation resistance measurement
- Continuity measurement

In this operating manual, vehicle manufacturers are exclusively defined as vehicle manufacturers in the Volkswagen Group.

Any use beyond what is listed here is prohibited.

## Requirements for the target group

Only qualified personnel may work with this product!

In this operating manual, qualified personnel is defined as personnel meeting all requirements for working on high-voltage systems applicable in the country of operation, as defined by:

- Regulations applicable in the country of operation
- Qualification according to DGUV 200-005 level 2 or higher, or equivalent
- Specifications from the vehicle manufacturer and/or the operator.

At all times while using the product, staff must wear the personal protective equipment prescribed by the vehicle manufacturer for work on high-voltage systems.

## Duties of the operator

The operator is responsible for ensuring that all staff working with the measurement adapter fulfills the requirements for the target group.

The operator is also responsible for ensuring that the following conditions are met:

- The measurement adapter is always in perfect working order.
- The regular inspection intervals for the measurement adapter are observed and recorded.

## Scope of delivery

Immediately check the condition of the product and the completeness of the delivery. If anything is missing or defective, please contact the manufacturer immediately.



- (1) High-voltage test adapter
- (2) USB stick with operating manual

## Design

Product design:

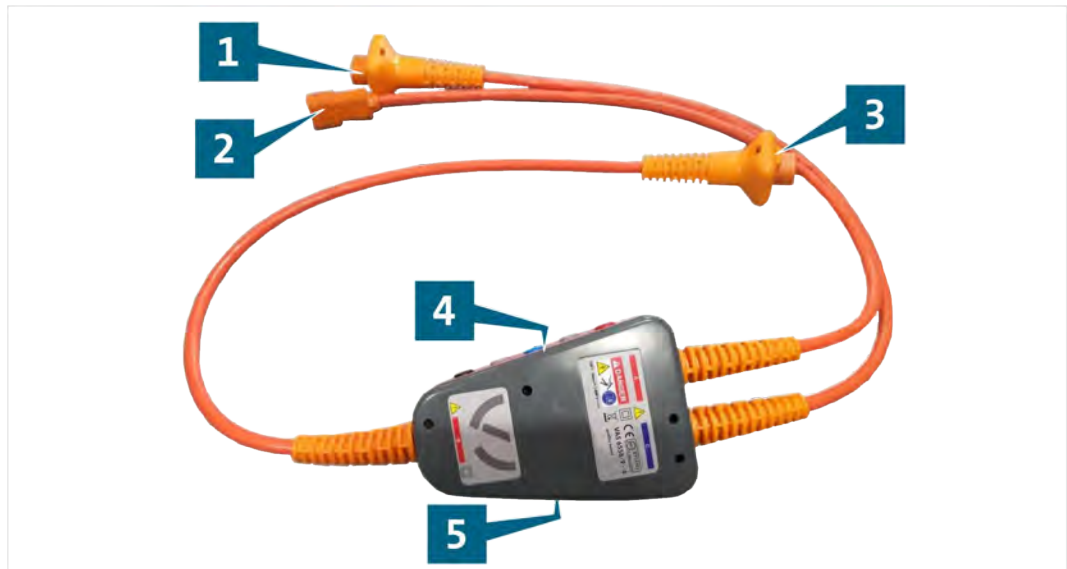









- (1) Plug (high-voltage cable)
- (2) Socket (air conditioning compressor to high-voltage cable)
- (3) Plug (high-voltage cable to air conditioning compressor)
- (4) Test sockets for air conditioning compressor (see wiring diagram)
- (5) Test sockets for high-voltage cables



## Symbols and connections



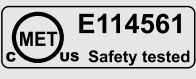
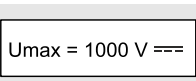
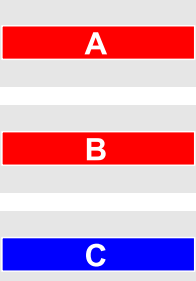







The following symbols are shown on the product:

Symbol	Meaning
	General warning symbols
	Electrical hazard! Read the operating manual!
	The serial number is used in conjunction with the manufacturer part number to identify the product.
	The manufacturer part number is used in conjunction with the serial number to identify the product.
	The product complies with protection class II, meaning it has increased or double insulation between active and accessible parts in accordance with VDE 0100, Part 410/412.1.
	The disposal instruction prohibits disposal of the product with household waste. Always dispose of the product in accordance with all local disposal regulations.
	The CE marking certifies that the product complies with all applicable European regulations and has been subjected to the prescribed conformity assessment procedure.
	The seal of approval identifies the product as having been approved for use in workshops and production facilities belonging to the vehicle manufacturer.
	The cMETus mark indicates that the product has been tested and certified by an NRTL in accordance with applicable standards. The manufacturer is listed under the number E114561 at the Eurofins testing labs.
	Indicates that the product is intended for measurements up to a maximum of 1000 V in accordance with IEC 61010-31.
	Line marking as assignment to the connection areas TP1 and TP2.
	Schematic wiring diagram (see wiring diagram)

The product has the following connection areas:

- TP1
- TP2

Each connection area has the following test sockets:

Connector	Function
 	Ground socket
 	Positive socket
 	Negative socket
 	Pilot socket
 	

## Wiring diagram

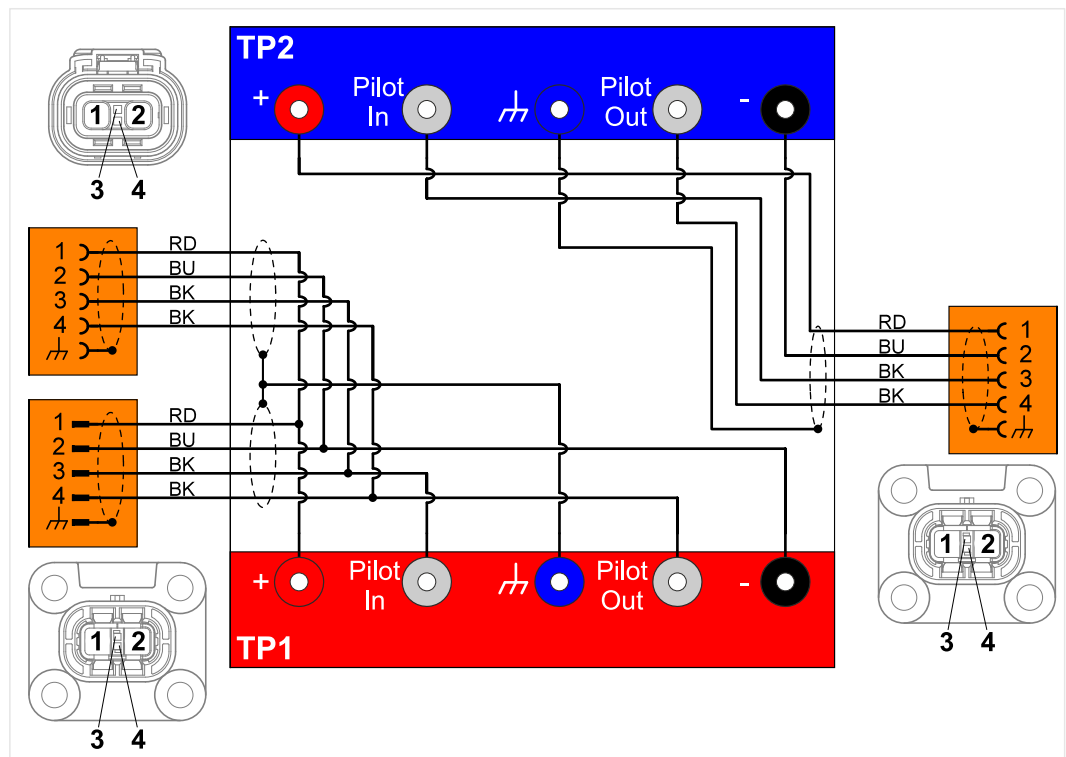

## Technical data

Rated data	Values
Manufacturer number	22101026
Maximum rated voltage	DC 1000 V
Maximum rated current	1 mA
Protection class	II / double insulated
Weight	~ 1325 g
Dimensions L/H/W	~ 180 mm/120 mm/55 mm
Cable length	850 mm

Ambient conditions	Operation	Storage	Transportation
Temperature	5 °C to 40 °C	-20 °C to 60 °C	-20 °C to 60 °C
Elevation above sea level	Max. 2000 m	No limitation	
Humidity	Max. 80 % up to 31° C, decreasing linearly to 50 % at 40° C	Max. 85 %	
	Condensation not permitted. Maximum permissible relative humidity: 60 % in environments with corrosive gas/air.		

This chapter provides information about the following activities:

- Startup
- Detaching the plug connection
- Cleaning
- Storage and transportation
- Disposal
- Maintenance



## **DANGER**

### **Danger of fatal electric shock!**

The electrical voltage in high-voltage systems is lethal and will cause death by electric shock!

- Use the product only on high-voltage systems and components that have been certifiably de-energized!



## **WARNING**

### **Danger of fatal electric shock!**

The electrical voltage in high-voltage systems is lethal and can cause death by electric shock!

- Use the product only for the applications intended by the vehicle manufacturer!



## **CAUTION**

### **Risk of damage!**

Plug connections lock into place when attached.

- Unlock the plug connections before you detach them! (See chapter “Detaching the plug connections”)

# Startup

## Measurement on the air conditioning compressor

1. Observe the safety instructions.



2. Connect the socket to the disconnected plug of the connection you want to test.
3. Lock the connection.
4. Connect the plug to the disconnected socket of the connection you want to test.
5. Lock the connection.
6. Connect the high-voltage measurement module to the high-voltage test adapter according to the guided fault finding. Use the test sockets in the red connection area.

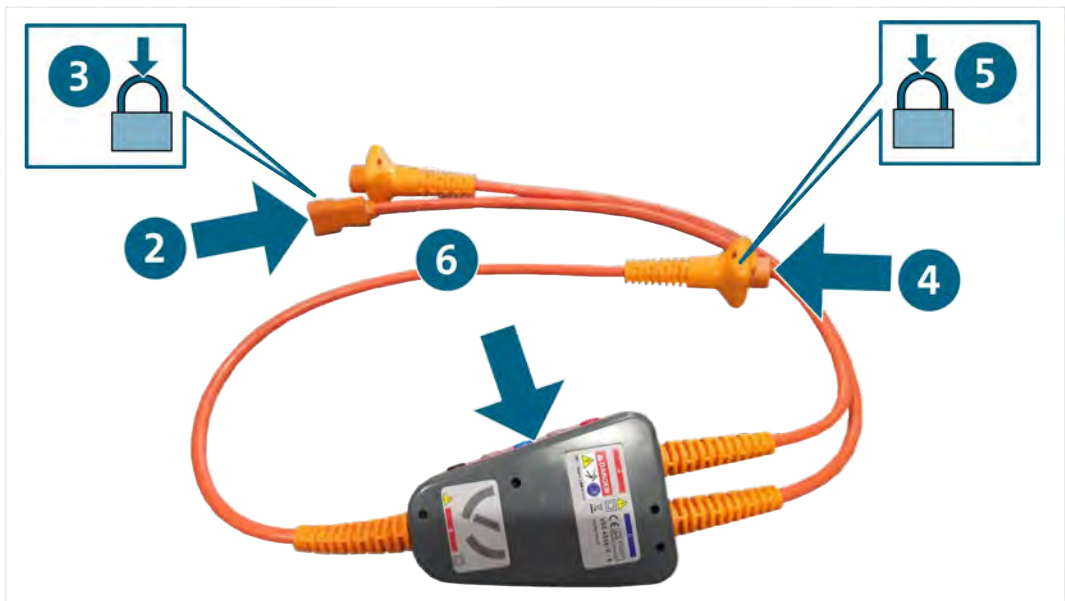

- ✓ You can now perform measurements in accordance with the guided fault finding.

## Measurement on the high-voltage cable

1. Observe the safety instructions.



2. Connect the plug to the disconnected socket of the connection you want to test.
3. Lock the connection.
4. Connect the high-voltage measurement module to the high-voltage test adapter according to the guided fault finding. Use the test sockets in the blue connection area.

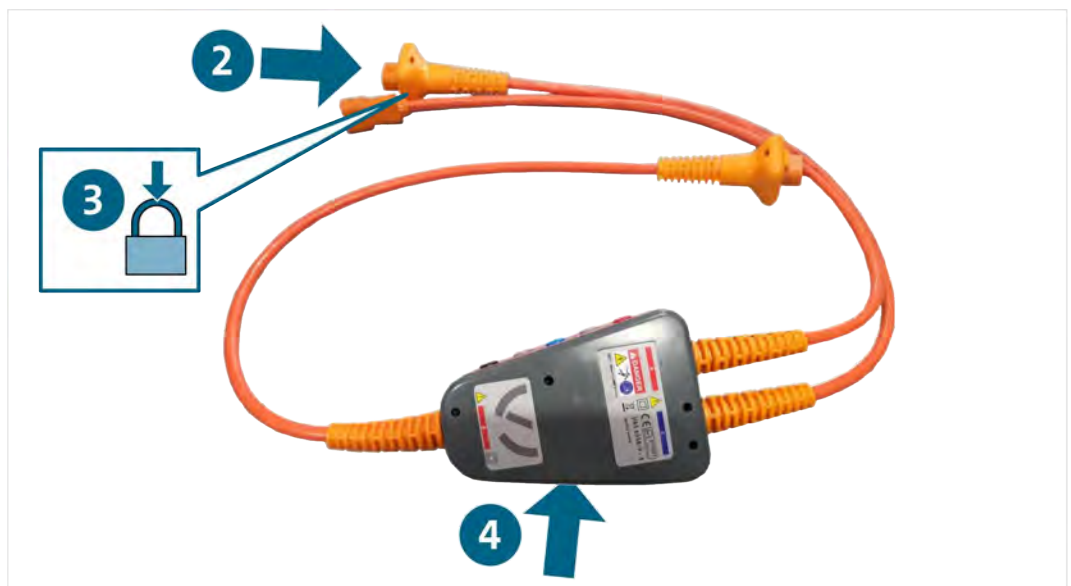

- ✓ You can now perform measurements in accordance with the guided fault finding.

## Detaching the plug connections



### WARNING

#### Risk of explosion!

Product components may produce sparks and electric arcs.

- Never disconnect high-voltage plug connections while under load!
- Do not use the product in potentially explosive atmospheres!
- Ensure that the product is at least 50 cm above the ground during operation!

The plug connections have an automatic locking mechanism. To detach a plug connection:

1. Make sure that the lever (red) is pulled out.
2. Push in the tongue (orange) and pull the plug connection apart as far as it will go.
3. Push the latch (black) in and pull the plug connection completely apart.

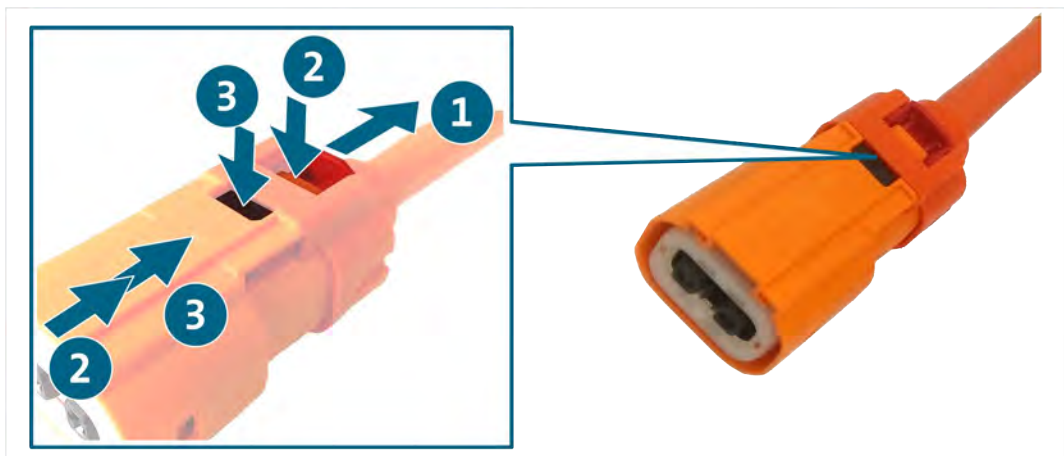

- ✓ The plug connection is now detached.

## Cleaning



### **DANGER**

#### **Danger of fatal electric shock!**

The electrical voltage in high-voltage systems is lethal and will cause death by electric shock!

- Disconnect the product from all power sources before cleaning the product!

Observe the safety instructions!

Use only a dry cloth to clean the product.

## Storage and transportation

Store the product in a dry and dust-free location when not in use.

## Disposal

Observe the safety instructions!

Always dispose of the product in accordance with all local disposal regulations.

## Maintenance

Observe the safety instructions!

National and local requirements for regular testing must be observed!

Test the product for proper function at intervals of no more than 24 months.

Contact the manufacturer to have a professional function test performed.



## Warranty

CAR-connect GmbH grants a warranty period of 24 months from the date of purchase. The warranty is valid for demonstrable defects in functional material and workmanship.

Further information on the warranty conditions can be found in the terms and conditions on the manufacturer's website.

## Customer service

Always include the serial number with any product queries. This number is found on the product.

CAR-connect GmbH  
Am Egelingsberg 8  
38542 Leiferde, Germany

Phone: +49 (0) 5373 – 92197-0

Fax: +49 (0) 5373 – 92197-88

[service@car-connect.cc](mailto:service@car-connect.cc)

[www.car-connect.cc](http://www.car-connect.cc)

Volkswagen Aktiengesellschaft  
K-GVO-LW  
Group After Sales – Group Service  
Literature and Systems  
Repair Shop Equipment  
PO box 011/4915  
38442 Wolfsburg, Germany

For internal use only  
Subject to technical changes  
Edition 12 / 2020